



1- Purchasing information

P.O. number:* _____ Date: _____

Company Name:* _____

Purchasing contact:* _____

Phone:* _____

Email:* _____

Contact preference:* Phone Email

Marked for: _____

3- Shipping information

Ship to:* _____

Name: _____

Address: _____

City: _____ Province: _____

Postal Code: _____

Phone: _____

2- Dealer/Representative information

Dealer/Representative:* _____

Phone:* _____

Email:* _____

Contact preference:* Phone Email

* Required

MA080
English Manual (STD)

MA081
French Manual

Taxes not included

MODEL							
WC19	<input type="checkbox"/>	Ultralight folding Helio A6 Wheelchair - 6000 series aluminum (265lb weight capacity)				WM0001489	\$2,345
WC09	<input type="checkbox"/>	HD Heavy duty kit (350 lb weight capacity)					\$850
Frame							
SEAT WIDTH ³							
SW	<input type="checkbox"/>	14" <input type="checkbox"/>	15" <input type="checkbox"/>	16" <input type="checkbox"/>	17" <input type="checkbox"/>	18" ¹ <input type="checkbox"/>	NC
	<input type="checkbox"/>	19" ¹ <input type="checkbox"/>	20" ¹ <input type="checkbox"/>	21" ² <input type="checkbox"/>	22" ² <input type="checkbox"/>	WAMA	\$320
SEAT DEPTH							
SD	<input type="checkbox"/>	14" <input type="checkbox"/>	15" <input type="checkbox"/>	16" <input type="checkbox"/>	17" <input type="checkbox"/>	18" <input type="checkbox"/>	NC
	<input type="checkbox"/>	19" <input type="checkbox"/>	20" <input type="checkbox"/>			WAMB	\$280
FRAME LENGTH ⁵							
SP01	<input type="checkbox"/>	Standard frame length configuration					STD
SP02	<input type="checkbox"/>	Frame length 1" longer than standard configuration					NC
SP03	<input type="checkbox"/>	Frame length 2" longer than standard configuration					NC
SP04	<input type="checkbox"/>	Frame length 1" shorter than standard configuration					NC
SP05	<input type="checkbox"/>	Frame length 2" shorter than standard configuration					NC
TRANSIT TIE DOWN							
AC04	<input type="checkbox"/>	Transit Tie Down (Unoccupied)					NC
AC05-S	<input type="checkbox"/>	WC-19 Transit Tie Down w/Q'straint belt ⁴ Short belt 20"-41"					\$370
AC05-L	<input type="checkbox"/>	WC-19 Transit Tie Down w/Q'straint belt ⁴ Long belt 20"-46"					\$370
AC35	<input type="checkbox"/>	WC-19 Transit Tie Down without belt ⁴					\$345

1- Available with HD Kit (350 lb); 2- Only with HD Kit (350 lb)

[3. Width calculator](#)

4- May interfere with swing away armrest and Clamp on height adjustable push handle; Not available with HD option

5- See table on page 8



PACKAGES

VP01	<input type="checkbox"/>	Vision Package: Orange accent added to point of contact accessories including: footrest latches, "T" and flip back armrest button cap, 6" Push to lock extension and rubber inserts on Newton composite angle adjustable footplates ¹	\$95
------	--------------------------	--	------

1- Please select footplates, footrest, armrest, push to lock wheel lock and the extensions in the appropriate sections; To know the compatible parts, look for this logo *VP01; Recommended with black chair; See picture of the product on page 7.

A6 FRONT Seat-to-floor Height - Please select your choice

Forks / Position	3" caster			4" caster			5" caster			6" caster			7" caster			8" caster		
	Stem bolt Length			Stem bolt Length			Stem bolt Length			Stem bolt Length			Stem bolt Length			Stem bolt Length		
	STD	+1"	+2"	STD	+1"	+2"	STD	+1"	+2"	STD	+1"	+2"	STD	+1"	+2"	STD	+1"	+2"
4"	P1	12"	13"	14"	12 1/2"	13 1/2"	14 1/2"											
	P2	12 1/2"	13 1/2"	14 1/2"	13"	14"	15"		14 1/2"	15 1/2"								
5"	P1																	
	P2				13"	14"	15"	13 1/2"	14 1/2"	15 1/2"								
	P3	13"	14"	15"	13 1/2"	14 1/2"	15 1/2"	14"	15"	16"		15 1/2"	16 1/2"					
	P4	13 1/2"	14 1/2"	15 1/2"	14"	15"	16"	14 1/2"	15 1/2"	16 1/2"	15"	16"	17"		16 1/2"	17 1/2"		
7"	P1										15 1/2"	16 1/2"	17 1/2"	16"	17"	18"		
	P2							15 1/2"	16 1/2"	17 1/2"	16"	17"	18"	16 1/2"	17 1/2"	18 1/2"		
	P3							16"	17"	18"	16 1/2"	17 1/2"	18 1/2"	17"	18"	19"	17 1/2"	18 1/2"
	P4	15 1/2"	16 1/2"	17 1/2"	16"	17"	18"	16 1/2"	17 1/2"	18 1/2"	17"	18"	19"	17 1/2"	18 1/2"	19 1/2"	18"	19"
	P5	16"	17"	18"	16 1/2"	17 1/2"	18 1/2"	17"	18"	19"	17 1/2"	18 1/2"	19 1/2"	18"	19"	20"	18 1/2"	19 1/2"
Froglegs	P1				13 1/2"	14 1/2"	15 1/2"											
	P2	13 1/2"	14 1/2"	15 1/2"	14"	15"	16"	14 1/2"	15 1/2"	16 1/2"								
	P3	14"	15"	16"	14 1/2"	15 1/2"	16 1/2"	15"	16"	17"	15 1/2"	16 1/2"	17 1/2"					

Height available +/- 1/4" (see stem bolt and fork combination at the end of the order form); Orange boxes are not available with a seat slope of more than 1.5in.

FRONT CASTERS

CASTERS		Availability	
CA01-03 to CA01-08	<input type="checkbox"/> Composite wheel w/ PU tire (1")	3", 4", 5", 6", 7", 8"	NC
CA10 to CA11	<input type="checkbox"/> Pneumatic casters (1 1/4")	6", 8"	\$170
CA14 to CA16	<input type="checkbox"/> Newton UltraCaster Composite (1 1/2")	4", 5", 6"	\$120
CA17 to CA19	<input type="checkbox"/> Newton UltraCaster Aluminum (1 1/2")	4", 5", 6"	\$198
CASTER OPTIONS			
CA12	<input type="checkbox"/> Caster Pin Locks (Available with +1" or +2" Stem bolt ONLY) ¹		WAMS \$275
CA13	<input type="checkbox"/> Carbon fiber Frog Legs suspension forks (Not available with caster pin locks)		\$525

1- Not available with WC-19

Helio A6 - REAR Seat-to-floor Height - Please select your choice

20" (451)	22" (501)	24" (540)	25" (559)	26" (590)
12"	13"	13 3/4" ¹	14 1/4"	14 3/4"
12 1/2"	13 1/2"	14 1/4"	14 3/4"	15 1/4"
13"	14"	14 3/4"	15 1/4"	15 3/4"
13 1/2"	14 1/2"	15 1/4"	15 3/4"	16 1/4"
14"	15"	15 3/4"	16 1/4"	16 3/4"
14 1/2"	15 1/2"	16 1/4"	16 3/4"	17 1/4"
15"	16"	16 3/4"	17 1/4"	17 3/4"
15 1/2"	16 1/2"	17 1/4"	17 3/4"	18 1/4"
16"	17"	17 3/4"	18 1/4"	18 3/4"
16 1/2"	17 1/2"	18 1/4"	18 3/4"	19 1/4"
17"	18"	18 3/4"	19 1/4"	19 3/4"
17 1/2"	18 1/2"	19 1/4" ¹	19 3/4"	20 1/4"

Configuration used: 1" seat slope with a center of gravity at 2" 1- Not available with One Arm Drive

Note: Tire size, center of gravity setting and seat slope may result in a variation of +/- 1/2" of selected seat to floor height"

REAR WHEELS

ONE ARM DRIVE ¹		Only available with Newton One rear wheel, permanent axles and 0° camber										
HR22	<input type="checkbox"/>	One arm drive - aluminum inner handrim ²	Left <input type="checkbox"/>	Right <input type="checkbox"/>		WAML	\$1,480					
HR60	<input type="checkbox"/>	One arm drive - plastic coated inner handrim ²	Left <input type="checkbox"/>	Right <input type="checkbox"/>		WAML	\$1,595					
HR98	<input type="checkbox"/>	Omit handrim on opposite side of the One Arm Drive (OAD)					NC					
REAR WHEELS		Available										
RW01	<input type="checkbox"/>	Mag ³			20", 22" 24"		\$150					
RW02	<input type="checkbox"/>	Newton One - spoke wheel ⁴			20", 22" 24"		NC					
RW03	<input type="checkbox"/>	Newton Gravity - ultralight wheel			20", 22", 24", 25", 26"		\$390					
RW04	<input type="checkbox"/>	Spinerger Spox	Bik STD <input type="checkbox"/>	Wht ⁵ <input type="checkbox"/>	Blue ⁵ <input type="checkbox"/>	Red ⁵ <input type="checkbox"/>	Yel ⁵ <input type="checkbox"/>	\$915				
RW05	<input type="checkbox"/>	Spinerger LX	Bik STD <input type="checkbox"/>	Pur ⁵ <input type="checkbox"/>	Wht ⁵ <input type="checkbox"/>	Blue ⁵ <input type="checkbox"/>	Red ⁵ <input type="checkbox"/>	Yel ⁵ <input type="checkbox"/>	Pink ⁵ <input type="checkbox"/>	Grn ⁵ <input type="checkbox"/>	Org ⁵ <input type="checkbox"/>	\$1,135
RW07	<input type="checkbox"/>	Spinerger CLX ⁶	Bik STD <input type="checkbox"/>	Pur ⁵ <input type="checkbox"/>	Wht ⁵ <input type="checkbox"/>	Blue ⁵ <input type="checkbox"/>	Red ⁵ <input type="checkbox"/>	Yel ⁵ <input type="checkbox"/>	Pink ⁵ <input type="checkbox"/>	Grn ⁵ <input type="checkbox"/>	Org ⁵ <input type="checkbox"/>	\$1,690
TIRES		Available										
AIRLESS												
TI01	<input type="checkbox"/>	Soft Urethane 1 3/8" - Low Tread, black			20", 22" 24"		STD					
TI02	<input type="checkbox"/>	Soft Urethane 1 3/8" - Medium Tread, black ⁷			22", 24", 25", 26"		\$120					
TI04	<input type="checkbox"/>	Soft Urethane 1" - No tread, black - <i>Shox</i>			22", 24", 25", 26"		\$150					
TI08	<input type="checkbox"/>	Pneumatic Airless insert 1 3/8" - Medium Tread ⁸			22", 24", 26"		\$235					
PNEUMATIC												
TI05	<input type="checkbox"/>	Pneumatic 1 3/8" - Medium Tread			20", 22", 24", 25", 26"		NC					
TI06	<input type="checkbox"/>	Pneumatic HP 1" - Low Tread, Puncture resistant, black - <i>SpeedLite</i>			20", 22", 24", 25", 26"		\$130					
TI07	<input type="checkbox"/>	Pneumatic HP 1" - Medium Tread, Puncture resistant, black - <i>TrailBlazer</i>			24", 25", 26"		\$210					
TI03	<input type="checkbox"/>	Pneumatic 2" - Large Tread, black ⁹			22", 24", 25"		\$140					

- 1- Offered with handrims on each side of the wheelchair; select the outer handrim in the handrims section; Only available with 24" wheel size; Not available with 21" and 22" wide;
 2- Only standard handrim position available; 3- Not compatible with HP tires; Only available with aluminum or plastic coated handrim, standard position; 4- Not compatible with Shox tires;
 5- color spokes require an additional 10 days lead-time; 6- Only available with 1" tires; 7- 22" is only available with Mags and Newton One rear wheels; 25" and 26" are not available with Newton Gravity wheels
 8- Not available with Spinerger CLX, Spinerger LX 25", 26" and Spox 25", 26" rear wheels; 9- Not available with armrests when 3° camber is selected.

HANDRIMS

HANDRIM		Available						
HR01	<input type="checkbox"/>	Aluminum anodized			20", 22", 24", 25", 26"		STD	
HR61	<input type="checkbox"/>	Aluminum black hard anodized ²			20", 22", 24", 25"		\$95	
HR02	<input type="checkbox"/>	Plastic coated ¹			20", 22", 24", 25", 26"	WAMO	\$180	
HR03	<input type="checkbox"/>	High friction coated ^{1,2,3}			22", 24", 25", 26"	WAMO	\$460	
HR07-HR18 and HR65-HR71	<input type="checkbox"/>	Newton Air Grip ²	See page 6 for the color selection and price			20", 22", 24", 25", 26"	WAMO	
HR28	<input type="checkbox"/>	Surge ^{1,2,3,4} (1 1/2" Oval handrim w/ Gripton high friction strip)			22", 24", 25", 26"		\$485	
HR05	<input type="checkbox"/>	Surge LT ^{1,2,3,4} (1 1/8" Oval handrim w/ Gripton high friction strip)			22", 24", 25", 26"		\$515	
HR04	<input type="checkbox"/>	Natural Fit ^{1,2,3,4}			22", 24", 25", 26"		\$320	
HR62	<input type="checkbox"/>	Simi H ^{1,2,3} (1 3/8" Oval handrim with high friction strip)			22", 24", 25", 26"		\$485	
HR63	<input type="checkbox"/>	Nova H ^{1,2,3} (1 1/4" Oval handrim with high friction strip)			22", 24", 25", 26"		\$515	
HR64	<input type="checkbox"/>	Optimum H ^{1,2,3} (1 1/8" heart-shaped handrim)			22", 24", 25", 26"		\$320	
HR99	<input type="checkbox"/>	Omit handrim					NC	

- 1- Only standard and narrow handrim position. By default, the tab won't be cut with the narrow position; 2- Not available with Maa wheels; 3- Not available with one arm drive;
 4- 25" and 26" are not available in narrow position; 24" is not available with the Spinerger Spox, LX and CLX in narrow position; CLX rear wheel are not available with thumb piece

HANDRIMS OPTION

ASSEMBLY POSITION							
HR29	<input type="checkbox"/>	Standard Handrim position	Full tab				STD
HR030	<input type="checkbox"/>	Narrow Handrim position no cut	Full tab				NC
HR30	<input type="checkbox"/>	Narrow Handrim position with cut ⁵	Short tab 2 positions				\$29
HR31	<input type="checkbox"/>	Super Narrow Handrim ⁵	Short tab 2 positions STD <input type="checkbox"/>		Short tab 1 position <input type="checkbox"/>		\$29
THUMB PIECE SELECTION FOR NATURAL FIT, SURGE, SURGE LT HANDRIMS							
HR23	<input type="checkbox"/>	Standard grip					\$200
HR27	<input type="checkbox"/>	Super grip					\$230
HR099	<input type="checkbox"/>	Omit thumb piece					NC

- 5- Only available with Aluminum and Air Grip handrims;

AXLE							
AX01	<input type="checkbox"/>	Quick release axle ¹				WAMU	\$100
AX02	<input type="checkbox"/>	Permanent axle					\$100
AX03	<input type="checkbox"/>	Quad release axle ¹				WAMU	\$280
AXLE PLATE							
AX04	<input type="checkbox"/>	Amputee adjustable axle plate ²				WAMT	\$280

- 1- Not required with one arm drive; 2- May interfere with swing away armrest and limit seat to floor height; Not available with WC-19 transit tie down

REAR WHEEL CAMBER							
CM00	<input type="checkbox"/>	0° camber					STD
CM03	<input type="checkbox"/>	3° camber					NC

CENTER OF GRAVITY

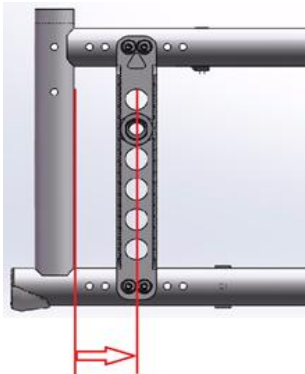

Choose position of rear wheel axle plate:

Measure distance from front of back post to center of axle receiver.

Default setting is at 1 1/4"

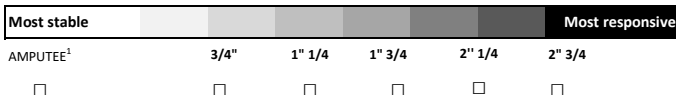

Motion Composites will select the closest possible center of gravity (COG) if an issue arises with the COG

1- Only available with amputee axle plate

WHEEL LOCK

WL08	<input type="checkbox"/>	Newton Wheel lock - push to lock			STD
WL16	<input type="checkbox"/>	Aluminum push to lock with extensions			\$85
WL02	<input type="checkbox"/>	Pull to lock			NC
WL04	<input type="checkbox"/>	Newton grade aid push to lock (works best with pneumatic or high pressure tire)		WAMR	\$200
WL13	<input type="checkbox"/>	6" removable extension handle ¹ *VP01			\$75
WL14					
WL05	<input type="checkbox"/>	Scissors Lock			\$200
WL06	<input type="checkbox"/>	Attendant Lock (additional set of wheel lock mounted to the back)			\$240
WL15	<input type="checkbox"/>	Unilateral wheel lock - pull to lock ² Left <input type="checkbox"/> Right <input type="checkbox"/>		WAMN	\$335
WL99	<input type="checkbox"/>	Omit wheel locks			NC

1- Only available with Newton push to lock (WL08), pull to lock (WL02) and Newton Grade aid (WL04); Only the extension for the Newton push to lock is available with the vision package (VP01)

2- For more information about incompatibilities and restriction, refer to the table at page 7 and the "How-to documents" page of our website:

https://www.motioncomposites.com/en_ca/support-and-education/how-to-documents

FOOTREST

SWING-IN/SWING-OUT FOOTREST

FR03-01	<input type="checkbox"/>	60° Swing-in/swing-out footrest - 13.5" - 17"		Set at*:		NC
FR03-02	<input type="checkbox"/>	60° Swing-in/swing-out footrest - 14.5" - 19.5"		Set at*:		NC
FR03-03	<input type="checkbox"/>	60° Swing-in/swing-out footrest - 15.5" - 20.5"		Set at*:		NC
FR04-01	<input type="checkbox"/>	70° Swing-in/swing-out footrest - 13.5" - 17"		Set at*:		NC
FR04-02	<input type="checkbox"/>	70° Swing-in/swing-out footrest - 14.5" - 19.5"		Set at*:		NC
FR04-03	<input type="checkbox"/>	70° Swing-in/swing-out footrest - 15.5" - 20.5"		Set at*:		NC
FR15-01	<input type="checkbox"/>	80° Swing-in/swing-out footrest - 13.5" - 16" ⁵		Set at*:		NC
FR15-02	<input type="checkbox"/>	80° Swing-in/swing-out footrest - 14.5" - 19.5" ⁵		Set at*:		NC
FR15-03	<input type="checkbox"/>	80° Swing-in/swing-out footrest - 15.5" - 20.5" ⁵		Set at*:		NC
FR06	<input type="checkbox"/>	90° swing-in/swing-out with front mount - Standard (no extension) ¹	7.5" - 11"	Set at*:		NC
FR07	<input type="checkbox"/>	90° swing-in/swing-out with front mount - Short extension ² ^{1,2}	9.5" - 13"	Set at*:		NC
FR08	<input type="checkbox"/>	90° swing-in/swing-out with front mount - Medium extension ⁴ ^{1,2}	9.5" - 14.5"	Set at*:		NC

FOOTREST OPTIONS

FR09	<input type="checkbox"/>	High mount (footplate attached to the hanger with clamps) ³	5" - 13.5"	Set at*:		\$105
FR10	<input type="checkbox"/>	Elevating legrest with calf pad, Length adjustable ⁴ Left <input type="checkbox"/> Right <input type="checkbox"/>	14" - 22"	Set at:	WAMK	\$295
FR99	<input type="checkbox"/>	Omit Footrest				NC

1- Available only with two piece adjustable footplates; 2- May interfere with front casters; 3- Not available with front mount and the elevating legrest; * +/- 1/2"

4- The elevating legrest replace the footrest side selected; Not available with one piece footplate; 5- Not available with 8" caster

FOOTPLATES

FP01	<input type="checkbox"/>	Standard - Composite ¹				STD
FP02	<input type="checkbox"/>	Newton adjustable angle - Composite ^{*VP01}			WAMJ	\$155
FP03	<input type="checkbox"/>	Newton adjustable angle - Aluminum			WAMJ	\$175
FP23	<input type="checkbox"/>	Newton adjustable angle extra deep - Aluminum			WAMJ	\$175
FP06	<input type="checkbox"/>	One piece adjustable angle flip-up - Aluminum		WAMJ	SEFND0015	\$215

FOOTPLATE ACCESSORIES

FP08	<input type="checkbox"/>	Length adjustable heel loop ²				NC
FP09	<input type="checkbox"/>	Calf strap			SEFND0010	\$62
FP30	<input type="checkbox"/>	Bodypoint Aeromesh Padded calf strap			SEFND0010	\$145

1- Not available with front mount; 2- not available with one piece footplate

SWING AWAY RESIDUAL LIMB SUPPORT

FR27	<input type="checkbox"/>	Residual limb support - flat 6"x8"	Left <input type="checkbox"/> Right <input type="checkbox"/>		SEFND0005	\$505
FR28	<input type="checkbox"/>	Residual limb support - flat 8"x10"	Left <input type="checkbox"/> Right <input type="checkbox"/>		SEFND0005	\$505
FR29	<input type="checkbox"/>	Residual limb support - flat 10"x10"	Left <input type="checkbox"/> Right <input type="checkbox"/>		SEFND0005	\$505
FR30	<input type="checkbox"/>	Residual limb support - flat 10"x14"	Left <input type="checkbox"/> Right <input type="checkbox"/>		SEFND0005	\$505
FR32	<input type="checkbox"/>	Residual limb support - contour 6"x8"	Left <input type="checkbox"/> Right <input type="checkbox"/>		SEFND0005	\$505
FR33	<input type="checkbox"/>	Residual limb support - contour 8"x10"	Left <input type="checkbox"/> Right <input type="checkbox"/>		SEFND0005	\$505

SEATING AND BACKREST

BACK UPHOLSTERY										
BH05	<input type="checkbox"/>	Slip-on Nylon back upholstery								NC
BH06	<input type="checkbox"/>	Adjustable tension Nylon back upholstery						WAMD/WAME		\$265
BH99	<input type="checkbox"/>	Omit Back upholstery								STD
	<input type="checkbox"/>	NXT back Support								See price list
SEAT CUSHION										
SC01	<input type="checkbox"/>	2" Cushion								\$185
SC02	<input type="checkbox"/>	3" Cushion								\$205
SC99	<input type="checkbox"/>	Omit seat cushion								STD
	<input type="checkbox"/>	NXT cushion								See price list
FIXED ANGLE BACK CANES WITH INTEGRATED PUSH HANDLE <i>(push handle included - no further selection needed)</i>										
BC58-915	<input type="checkbox"/>	Straight aluminum back cane	9" - 15"	<i>increment of 1/2"</i>		Set at ² :			NC	
BC58-1521	<input type="checkbox"/>	Straight aluminum back cane	15" - 21"	<i>increment of 1/2"</i>		Set at ² :			NC	
BC60	<input type="checkbox"/>	Straight aluminum back cane	21" - 24"	<i>increment of 1"</i>		Set at ² :			\$100	
BC01-16	<input type="checkbox"/>	8° bend aluminum back cane	16"						NC	
BC01-18	<input type="checkbox"/>	8° bend aluminum back cane	18"						NC	
BC01-20	<input type="checkbox"/>	8° bend aluminum back cane	20"						NC	
BC59	<input type="checkbox"/>	8° bend aluminum back cane	21" - 24"	<i>increment of 1"</i>		Set at ² :			\$100	
FIXED ANGLE, HEIGHT ADJUSTABLE BACK CANES WITH PUSH HANDLE OPTIONS <i>(MUST select ONE push handle options)</i>										
BC11-912	<input type="checkbox"/>	Straight aluminum back cane	9" - 12"	<i>increment of 1/2"</i>		Set at ² :			\$80	
BC11-1215	<input type="checkbox"/>	Straight aluminum back cane	12" - 15"	<i>increment of 1/2"</i>		Set at ² :			\$80	
BC11-1518	<input type="checkbox"/>	Straight aluminum back cane	15" - 18"	<i>increment of 1/2"</i>		Set at ² :			\$80	
BC11-1821	<input type="checkbox"/>	Straight aluminum back cane	18" - 21"	<i>increment of 1/2"</i>		Set at ² :			\$80	
BC12-1315	<input type="checkbox"/>	8° bend aluminum back cane	13.5" - 15"	<i>increment of 1/2"</i>		Set at ² :			\$85	
BC12-1518	<input type="checkbox"/>	8° bend aluminum back cane	15" - 18"	<i>increment of 1/2"</i>		Set at ² :			\$85	
BC12-1821	<input type="checkbox"/>	8° bend aluminum back cane	18" - 21"	<i>increment of 1/2"</i>		Set at ² :			\$85	
ANGLE AND HEIGHT ADJUSTABLE BACK CANE WITH PUSH HANDLE OPTIONS <i>(MUST select ONE push handle options)</i>										
BC13-1518	<input type="checkbox"/>	Straight aluminum back cane	15" - 18"	<i>increment of 1/2"</i>		Set at ² :			\$275	
BC13-1821	<input type="checkbox"/>	Straight aluminum back cane	18" - 21"	<i>increment of 1/2"</i>		Set at ² :			\$275	
BC14-1518	<input type="checkbox"/>	8° bend aluminum back cane	15" - 18"	<i>increment of 1/2"</i>		Set at ² :			\$330	
BC14-1821	<input type="checkbox"/>	8° bend aluminum back cane	18" - 21"	<i>increment of 1/2"</i>		Set at ² :			\$330	
		Select back cane angle:	85° ¹ <input type="checkbox"/>	90° STD <input type="checkbox"/>	95° <input type="checkbox"/>	100° <input type="checkbox"/>	105° <input type="checkbox"/>	110° <input type="checkbox"/>		
PUSH HANDLES OPTIONS <i>(ONE option at a time)</i>										
PH01	<input type="checkbox"/>	Push handles								STD
PH05	<input type="checkbox"/>	Fold down push handles ^{3,5}								\$165
PH06-920	<input type="checkbox"/>	Clamp on height adjustable push handles 9"-20" ^{3,4,5}								\$345
PH06-923	<input type="checkbox"/>	Clamp on height adjustable push handles 9"-23" ^{3,4,5}								\$345
PH02	<input type="checkbox"/>	Omit push handles								NC
STROLLER HANDLE AND STABILIZER BAR <i>(only available with push handle)</i>										
PH04	<input type="checkbox"/>	Stroller handle <i>(not available with the HD option)</i>						WAMW		\$220
PH03	<input type="checkbox"/>	Newton folding stabilizer bar <i>(not available with stroller handle)</i>								\$275

1- Not compatible with 8 degree bent back cane; 2- If not indicated, default height setting is at the lowest position; measured from seat sling to top of back upholstery; 3- 265lb weight limit
 4- Not compatible with swing away armrests, 8° bend back canes, 9-12" and 21-24" back canes and amputee axle plates; 5- Not compatible with stroller handler, stabilizer bar, headrest and attendant lock;

ARMRESTS

HEIGHT ADJUSTABLE FLIP BACK ARMREST <i>(Convertible to "T" armrest) ^{1,4} *VP01</i>										
AR01-812	<input type="checkbox"/>	10" Desk length armpad	8" - 12"	Locked <input type="checkbox"/>	Unlocked STD <input type="checkbox"/>				\$405	
AR01-1014	<input type="checkbox"/>	10" Desk length armpad	10" - 14"	Locked <input type="checkbox"/>	Unlocked STD <input type="checkbox"/>				\$405	
AR02-812	<input type="checkbox"/>	14" Full length armpad	8" - 12"	Locked <input type="checkbox"/>	Unlocked STD <input type="checkbox"/>				\$405	
AR02-1014	<input type="checkbox"/>	14" Full length armpad	10" - 14"	Locked <input type="checkbox"/>	Unlocked STD <input type="checkbox"/>				\$405	
HEIGHT ADJUSTABLE "T" ARMREST ¹ *VP01										
AR13-610	<input type="checkbox"/>	10" Desk length armpad ⁵	6" - 10"						\$385	
AR13-812	<input type="checkbox"/>	10" Desk length armpad	8" - 12"						\$385	
AR13-1014	<input type="checkbox"/>	10" Desk length armpad	10" - 14"						\$385	
AR14-610	<input type="checkbox"/>	14" Full length armpad ⁵	6" - 10"						\$385	
AR14-812	<input type="checkbox"/>	14" Full length armpad	8" - 12"						\$385	
AR14-1014	<input type="checkbox"/>	14" Full length armpad	10" - 14"						\$385	
SWING AWAY ARMREST ²										
AR05	<input type="checkbox"/>	Tubular armrest - Short pad	8" - 11"						\$325	
AR23	<input type="checkbox"/>	Tubular armrest - long pad	8" - 11"						\$325	
AR06	<input type="checkbox"/>	10" Desk length flat armpad	8" - 11"						\$325	
AR17	<input type="checkbox"/>	14" Full length flat armpad	8" - 11"						\$325	
ARMREST OPTIONS										
AR12	<input type="checkbox"/>	14" Full Length armpad - Gel Ovation (pair) ³						SEAND0030		\$160
AR99	<input type="checkbox"/>	Omit armrest								NC

1- May have 1/2" adjustment restriction on both limits of the range; 2- Could interfere with some rigid backrests; Not available with attendant lock and fixed carbon fiber side guards;
 3- Only available with full length armrest; Not available with swing away and desk length armrests; 4- Not available with attendant lock; 5- May have some restriction with seat-to-floor height and rear wheel

ACCESSORIES

SIDE GUARDS (not available with Flip Back and "T" Armrest)							
SG01	<input type="checkbox"/>	Plastic side guards (removable)	Straight bracket - STD	Offset bracket ¹		WAMV	\$235
SG02	<input type="checkbox"/>	Carbon fiber side guards (fixed)				WAMV	\$285
SG03	<input type="checkbox"/>	Carbon fiber side guards (removable)	Straight bracket - STD	Offset bracket ¹		WAMV	\$320
SG06	<input type="checkbox"/>	Plastic fender side guards (removable)	Straight bracket - STD	Offset bracket ¹		WAMV	\$340
SG04	<input type="checkbox"/>	Carbon fiber fender side guards (removable)	Straight bracket - STD	Offset bracket ¹		WAMV	\$535
SG99	<input type="checkbox"/>	Omit side guard					NC

1- only compatible with 0° camber; Increase width by 1/2" per side for a total of 1" ;

POSITIONING BELT							
SB01-S	<input type="checkbox"/>	Velcro adjustable - Small 35" ¹					\$50
SB01-L	<input type="checkbox"/>	Velcro adjustable - Long 60"					\$50
SB02-S	<input type="checkbox"/>	Auto buckle - Small 35" ¹					\$80
SB02-M	<input type="checkbox"/>	Auto buckle - Medium 48"					\$80
SB02-L	<input type="checkbox"/>	Auto buckle - Long 60"					\$80
SB04-M	<input type="checkbox"/>	BodyPoint Hip Belt - 2 point not padded - Medium 56"					\$105
SB04-L	<input type="checkbox"/>	BodyPoint Hip Belt - 2 point not padded - Long 61"					\$105
SB05-S	<input type="checkbox"/>	BodyPoint Hip Belt - 2 point padded - Small 51"				SERND0030	\$195
SB05-M	<input type="checkbox"/>	BodyPoint Hip Belt - 2 point padded - Medium 56"				SERND0030	\$195
SB05-L	<input type="checkbox"/>	BodyPoint Hip Belt - 2 point padded - Long 61"				SERND0030	\$195
SB06-S	<input type="checkbox"/>	BodyPoint Hip Belt - 4 point padded - Small 51"				SERND0020	\$220
SB06-M	<input type="checkbox"/>	BodyPoint Hip Belt - 4 point padded - Medium 56"				SERND0020	\$220
SB06-L	<input type="checkbox"/>	BodyPoint Hip Belt - 4 point padded - Long 61"				SERND0020	\$220
SB03	<input type="checkbox"/>	Hardware attachment for 2 extra points (1 pair)					\$15
SB08-M	<input type="checkbox"/>	BodyPoint EVOFLEX® Positioning Belt Rehab latch and Band Clamps - Medium 18"					\$365
SB08-L	<input type="checkbox"/>	BodyPoint EVOFLEX® Positioning Belt Rehab latch and Band Clamps - Long 24"					\$365
SB99	<input type="checkbox"/>	Omit positioning belt					STD

1- Not recommended for seat width of 18" and more

HEADREST							
AC01-S	<input type="checkbox"/>	Profiled Headrest - Small (3.5"X6")					\$215
AC01-M	<input type="checkbox"/>	Profiled Headrest - Medium (4.5"X7")					\$215
AC01-L	<input type="checkbox"/>	Profiled Headrest - Large (5.5"X8")					\$215
AC28	<input type="checkbox"/>	Headrest mounting hardware with removable non folding stabilizer bar ¹					\$365

1- Only available with push handles - Not available with a stroller handle or a folding stabilizer bar

ACCESSORIES							
AC03	<input type="checkbox"/>	Anti-tippers					\$125
AC29	<input type="checkbox"/>	Swing-away anti-tipper ¹	Left <input type="checkbox"/>	Right <input type="checkbox"/>			\$190
AC27	<input type="checkbox"/>	Tip assist ²					\$70
AC06	<input type="checkbox"/>	Cane and crutch holder	Left <input type="checkbox"/>	Right <input type="checkbox"/>			\$115
AC07	<input type="checkbox"/>	Oxygen tank holder ⁴ - D and E Type - Installed to the left					\$395
AC08	<input type="checkbox"/>	Spoke guards ³	Available: 20", 22", 24", 25", 26"			WAMP	\$165
AC09	<input type="checkbox"/>	Footrest neoprene impact guard (pair) - Black				SEFND0035	\$90
AC10	<input type="checkbox"/>	Seat pouch					\$105
AC30	<input type="checkbox"/>	Newton multi-purpose pouch					\$80
AC26	<input type="checkbox"/>	BodyPoint Mobility Bag					\$150
AC23	<input type="checkbox"/>	Newton Backpack					\$135
AC12	<input type="checkbox"/>	Velcro Closing Strap					\$60
AC13	<input type="checkbox"/>	Tool kit					\$60

1- Must select the pair (left and right) with HD option; Only available with rear seat to floor height between 13 1/2" and 19 3/4"; Not available with amputee axle plate; 2- Cannot be combined with Anti Tippers; 3- Not available with Mag wheels and Spinegy; the 24" spoke guard will be installed on the 25" wheel; 4- Not compatible with swing away armrest, amputee axle plate and WC-19 transit tie-down

Colors

Options ¹	Black	Sunkissed Orange	Burgundy	Sapphire Blue	Monster Green	Charcoal	Fuchsia	Steel Blue	Ferrari Red	Acid Green	Electric Purple	Caribbean Blue	White	Pink Pearl	Plum Purple	Sky Blue	Black Cherry	Khaki Green (matte)	Desert Sand (matte)		
AirGrip	<input type="checkbox"/>	<input type="checkbox"/>	<input type="checkbox"/>	<input type="checkbox"/>	<input type="checkbox"/>	<input type="checkbox"/>	<input type="checkbox"/>	<input type="checkbox"/>	<input type="checkbox"/>	<input type="checkbox"/>	<input type="checkbox"/>	<input type="checkbox"/>	<input type="checkbox"/>	<input type="checkbox"/>	<input type="checkbox"/>	<input type="checkbox"/>	<input type="checkbox"/>	<input type="checkbox"/>	<input type="checkbox"/>	<input type="checkbox"/>	\$350
Frame ²	<input type="checkbox"/>	<input type="checkbox"/>	<input type="checkbox"/>	<input type="checkbox"/>	<input type="checkbox"/>	<input type="checkbox"/>	<input type="checkbox"/>	<input type="checkbox"/>	<input type="checkbox"/>	<input type="checkbox"/>	<input type="checkbox"/>	<input type="checkbox"/>	<input type="checkbox"/>	<input type="checkbox"/>	<input type="checkbox"/>	<input type="checkbox"/>	<input type="checkbox"/>	<input type="checkbox"/>	<input type="checkbox"/>	<input type="checkbox"/>	NC
FC99	<input type="checkbox"/>	Custom Color	Specify PPG Paintit color:																	additional 10 days lead-time	\$422

1- Color representation may vary from one monitor to another. Therefore, the actual paint color on your wheelchair might differ slightly from what you see on your screen.; Finish between Airgrip and frame might be different; 2- with black hydroformed aluminum crossbrace

Fork and Stem bolt combinations

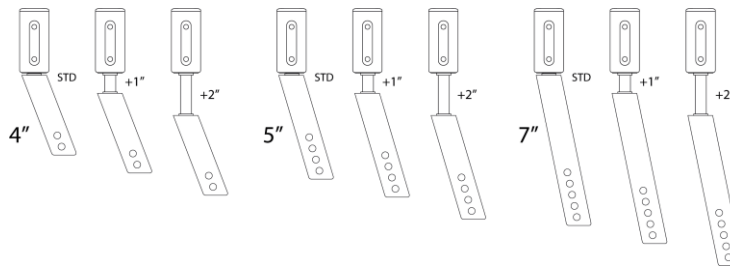

Frame length chart

Frame length	Seat Depth						
	14"	15"	16"	17"	18"	19"	20"
STD							
+1							N/A
+2						N/A	N/A
-1	N/A						
-2	N/A	N/A					

Unilateral wheel lock restrictions

Seat depth: shall be 16 in and greater		
Rear wheel: shall be 24 in and less		
"T" or flip-back armrest only compatible with 0° Camber		
One arm drive: Not compatible with "T" or flip-back armrest		
"T" or flip-back armrest may require to move the rear wheels outwards		
Not compatible with wheel lock lever extension		
Rear wheel diameter	Seat depth (in)	COG Compatibility Range (in)
20 in	16+	1.25 to 2.75
	16	0.75 to 2.25
22 in	17+	0.75 to 2.75
	16	0.75 to 1.75
24 in	17	0.75 to 2.25
	18+	0.75 to 2.75



CUSTOMIZATION STARTS HERE!

With EVO Custom, whether it's a subtle tweak for comfort or mobility, or a fully reimagined component tailored to your unique needs, we're here to support you.



Explore the EVO Custom Catalog.

You can include your request or reference an existing customization from our catalog in the notes section below.





Have a customization in mind or a specific request? The EVO Custom Request Form is the best place to start.

Note :

THORACIC SHAPE			Optima™ DEEP THORACIC BACK SUPPORT					
	WIDTH	HEIGHT	MODEL # ALUMINUM	RETAIL	✓	Repl. cover & foam	Retail	✓
	14"	13"	NOPCB1413	\$990		NIB-2246V	\$156	
	14"	16"	NOPCB1416	\$990		NIB-2247V	\$156	
	15"	13"	NOPCB1513	\$990		NIB-2250V	\$156	
	15"	16"	NOPCB1516	\$990		NIB-2251V	\$156	
	16"	13"	NOPCB1613	\$990		NIB-2254V	\$156	
	16"	16"	NOPCB1616	\$990		NIB-2255V	\$156	
	16"	19"	NOPCB1619	\$990		NIB-2256V	\$156	
	17"	13"	NOPCB1713	\$990		NIB-2259V	\$156	
17"	16"	NOPCB1716	\$990		NIB-2260V	\$156		
18"	13"	NOPCB1813	\$990		NIB-2264V	\$156		
18"	16"	NOPCB1816	\$990		NIB-2265V	\$156		
18"	19"	NOPCB1819	\$990		NIB-2266V	\$156		
19"	16"	NOPCB1916	\$990		NIB-2267V	\$156		
19"	19"	NOPCB1919	\$990		NIB-2268V	\$156		
20"	13"	NOPCB2013	\$990		NIB-2271V	\$156		
20"	16"	NOPCB2016	\$990		NIB-2272V	\$156		
20"	19"	NOPCB2019	\$990		NIB-2273V	\$156		
21"	16"	NOPCB2116	\$1,032		NIB-2274V	\$156		
21"	19"	NOPCB2119	\$1,032		NIB-2275V	\$156		
22"	13"	NOPCB2213	\$1,032		NIB-2276V	\$156		
22"	16"	NOPCB2216	\$1,032		NIB-2277V	\$156		
22"	19"	NOPCB2219	\$1,032		NIB-2278V	\$156		

		Optima Carbon™ DEEP THORACIC BACK SUPPORT CARBON FIBER SHELL (WEIGHT SAVINGS – 1lb)					
WIDTH	HEIGHT	MODEL # CARBON	RETAIL	✓	Repl. cover &	Retail	✓
14"	13"	NOCFPCB1413	\$1,500		NIB-2246V	\$156	
14"	16"	NOCFPCB1416	\$1,500		NIB-2247V	\$156	
15"	13"	NOCFPCB1513	\$1,500		NIB-2250V	\$156	
15"	16"	NOCFPCB1516	\$1,500		NIB-2251V	\$156	
16"	13"	NOCFPCB1613	\$1,500		NIB-2254V	\$156	
16"	16"	NOCFPCB1616	\$1,500		NIB-2255V	\$156	
17"	13"	NOCFPCB1713	\$1,500		NIB-2259V	\$156	
17"	16"	NOCFPCB1716	\$1,500		NIB-2260V	\$156	
18"	13"	NOCFPCB1813	\$1,500		NIB-2264V	\$156	
18"	16"	NOCFPCB1816	\$1,500		NIB-2265V	\$156	
20"	13"	NOCFPCB2013	\$1,500		NIB-2271V	\$156	
20"	16"	NOCFPCB2016	\$1,500		NIB-2272V	\$156	

THORACIC SHAPE			Xtend™ LOW HEIGHT ADJUSTABLE THORACIC BACK SUPPORT					
	xtend™	WIDTH	HEIGHT	RETAIL	✓	Repl. cover & foam	Retail	✓
	NHAACB(L)1213/17	12"	13-17"	\$870		NIB-2148V	\$156	
	NHAACB(L)1413/17	14"	13-17"	\$870		NIB-2149V	\$156	
	NHAACB(L)1613/17	16"	13-17"	\$870		NIB-2150V	\$156	
	NHAACB(L)1813/17	18"	13-17"	\$870		NIB-2151V	\$156	
	NHAACB (L)2013/17	20"	13-17"	\$870		NIB-2152V	\$156	
	NHAACB (L)2213/17	22"	13-17"	\$906		NIB-2153V	\$156	

		Xtend™ DEEP HEIGHT ADJUSTABLE THORACIC BACK SUPPORT					
xtend™ Deep	WIDTH	HEIGHT	RETAIL	✓	Repl. cover &	Retail	✓
NHAPCB1616/20	16"	16"-20"	\$870		NIB-2143V	\$156	
NHAPCB1816/20	18"	16"-20"	\$870		NIB-2144V	\$156	
NHAPCB2016/20	20"	16"-20"	\$870		NIB-2145V	\$156	
NHAPCB2216/20	22"	16"-20"	\$906		NIB-2146V	\$156	

PELVIC SHAPE			Classic™ PELVIC BACK SUPPORT					
	Classic™	WIDTH	HEIGHT	RETAIL	✓	Repl. cover & foam	Retail	✓
	NACB1616	16"	16"	\$870		NIB-2163V	\$156	
	NACB1618	16"	18"	\$870		NIB-2164V	\$156	
	NACB1816	18"	16"	\$870		NIB-2166V	\$156	
	NACB1818	18"	18"	\$870		NIB-2167V	\$156	
	NACB1820	18"	20"	\$870		NIB-2168V	\$156	
	NACB2020	20"	20"	\$870		NIB-2171V	\$156	
	NACB2216	22"	16"	\$906		NIB-2172V	\$156	
	NACB2218	22"	18"	\$906		NIB-2173V	\$156	
NACB2220	22"	20"	\$906		NIB-2174V	\$156		

		Classic™ DEEP PELVIC BACK SUPPORT					
Classic™ Deep	WIDTH	HEIGHT	RETAIL	✓	Repl. cover & foam	Retail	✓
NPCB1616	16"	16"	\$996		NIB-2175V	\$156	
NPCB1618	16"	18"	\$996		NIB-2176V	\$156	
NPCB1818	18"	18"	\$996		NIB-2179V	\$156	
NPCB1820	18"	20"	\$996		NIB-2180V	\$156	
NPCB2020	18"	20"	\$996		NIB-2183V	\$156	
NPCB2216	20"	16"	\$1,032		NIB-2184V	\$156	
NPCB2218	22"	18"	\$1,032		NIB-2185V	\$156	
NPCB2220	22"	20"	\$1,032		NIB-2186V	\$156	

PLEASE NOTE: Each back will fit widths up to 2" wider.



ALL PRICES QUOTED IN CAD PRICES ARE SUBJECT TO CHANGE WITHOUT NOTICE.

For additional NXT models, sizes and hardware not shown, please refer to the complete NXT Seating Order Form at www.motioncomposites.com



BACK SUPPORT ACCESSORIES

	MODEL #	DESCRIPTION	FITS BACK WIDTH	RETAIL	QTY
	Custom - Cover	Optional Infection Control Wipe Down Back Support Cover	Specify back model # when ordering	\$246	
	NIB-1938	Extra Small Privacy Flap for 11" - 13" wide back supports	11" - 13" (27.9 - 33.0)	\$84	
	NIB-1078	Small Privacy Flap for 14"-16" wide back supports	14" - 16" (35.6-40.6 cm)	\$84	
	NIB-1079	Medium Flap for 17"-19" wide back supports	17" - 19" (43.2-48.3 cm)	\$84	
	NIB-1080	Large Privacy Flap for 20"-22" wide back supports	20" - 22" (50.8-55.9 cm)	\$84	
	NIB-1081	Extra Large Privacy Flap for 23" - 26" wide back supports	23" - 26" (58.4 - 66.0 cm)	\$84	

MultiFit™ HEAD SUPPORT – MULTI-ADJUSTABLE PADS

	MODEL	Description	RETAIL	✓
	NIB-0784	10" x 5" Large Rectangular	\$246	
	NIB-0818	14" x 5" Extra-Large Rectangular	\$246	

MultiFit™ HEAD SUPPORT – FIXTURES

	MODEL	Description	RETAIL	✓
	NIB-0747	Multi-Axis Hardware	\$180	
	NIB-0823	Head Support Receiver Bracket	\$72	

EXTRA COVERS

Extra Outer smartx3D Cover



Extra Outer Incontinent Cover



ITEM	WIDTH X DEPTH	RETAIL	QTY
Extra Outer smartx ^{3D} Cover – For a cover up to 18" x 18"	NXCCBF _____ v	\$156	
Extra Outer smartx ^{3D} Cover – For a cover 18" x 20" and above	NXCCBF _____ v	\$180	
Extra Outer Incontinent Cover – For a cover up to 18" x 18"	NXCCAF _____ v	\$156	
Extra Outer Incontinent Cover – For a cover 18" x 20" and above	NXCCAF _____ v	\$180	

ALL PRICES QUOTED IN CAD PRICES ARE SUBJECT TO CHANGE WITHOUT NOTICE.

For additional NXT models, sizes and hardware not shown, please refer to the complete NXT Seating Order Form at www.motioncomposites.com