



1- Purchasing information

P.O. number:* _____ Date: _____
 Company Name:* _____
 Purchasing contact:* _____
 Phone:* _____
 Email:* _____
 Contact preference:* Phone Email
 Marked for: _____

2- ATP/Clinician information

ATP/Clinician:* _____
 Phone:* _____
 Email:* _____
 Contact preference:* Phone Email

3- Shipping information

Ship to:* _____
 Name: _____
 Address: _____
 City: _____ State: _____
 Zip Code: _____
 Phone: _____

* Required

MA082
 English Manual (STD)

MA089
 Spanish Manual

Taxes not included

MODEL				USD					
WC25	<input checked="" type="checkbox"/>	Veloce wheelchair - Helio Base (265 lb weight limit)		K0005	\$2,395				
WC23	<input checked="" type="checkbox"/>	Carbon Fiber Frame			\$2,125				
WC24	<input checked="" type="checkbox"/>	Fixed Front End			\$1,275				
WC09	<input type="checkbox"/>	HD Heavy Duty package (350 lb weight capacity)			\$535				
WC10	<input type="checkbox"/>	E-Motion adaptor Kit (2 adaptors) - Only necessary with 6° camber			\$36				
Frame									
SEAT WIDTH ³									
SW	<input type="checkbox"/>	14" <input type="checkbox"/>	15" <input type="checkbox"/>	16" <input type="checkbox"/>	17" <input type="checkbox"/>	18" ² <input type="checkbox"/>	19" ² <input type="checkbox"/>		NC
	<input type="checkbox"/>	20" ² <input type="checkbox"/>	21" ⁷ <input type="checkbox"/>	22" ⁷ <input type="checkbox"/>				E2201	\$505
SEAT DEPTH									
SD	<input type="checkbox"/>	14" ¹ <input type="checkbox"/>	15" <input type="checkbox"/>	16" <input type="checkbox"/>	17" <input type="checkbox"/>	18" <input type="checkbox"/>	19" <input type="checkbox"/>		NC
	<input type="checkbox"/>	20" <input type="checkbox"/>						E2203	\$485
FRAME LENGTH (Seat sling depth plus distance from seat sling to front of frame) ⁴									
SP01	<input type="checkbox"/>	Standard frame length configuration ⁵							STD
SP02	<input type="checkbox"/>	Frame length 1" longer than standard configuration							NC
SP03	<input type="checkbox"/>	Frame length 2" longer than standard configuration							NC
SP04	<input type="checkbox"/>	Frame length 1" shorter than standard configuration							NC
SP05	<input type="checkbox"/>	Frame length 2" shorter than standard configuration							NC
TRANSIT TIE DOWN									
AC05-S	<input type="checkbox"/>	WC-19 Transit Tie Down w/Q'straint belt ⁶		Short belt 20"-41"					\$365
AC05-L	<input type="checkbox"/>	WC-19 Transit Tie Down w/Q'straint belt ⁶		Long belt 20"-46"					\$365
AC35	<input type="checkbox"/>	WC-19 Transit Tie Down without belt ⁶							\$335

1- Only available with frame length 1" and 2" longer; 2- Available with HD option; When HD option is selected, only the one piece angle adjustable flip-up footplate is available;

3- Width calculator; 4- See chart on page 7; 5- 4.375" from seat sling to front frame;

6- May interfere with swing away armrest and Clamp on height adjustable push handle; Not available with HD option; 7- Only available with HD option and the one piece adjustable angle flip-up

FRONT Seat-to-floor height

Caster sizes	Height available +/- 1/4"	Specify desired height: _____ (inches)
<input type="checkbox"/> 3" Caster	14" to 21"	
<input type="checkbox"/> 4" Caster	14.5" to 21"	
<input type="checkbox"/> 5" Caster	15.5" to 21"	
<input type="checkbox"/> 6" Caster	16.5" to 21" (N/A with 90° front frame)	

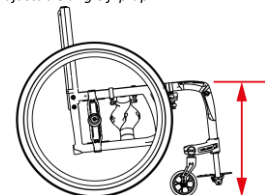

CASTERS			Availability		
CA01-03 to CA01-06	<input type="checkbox"/>	Composite wheel w/ PU tire (1")		3", 4", 5", 6"	NC
CA10	<input type="checkbox"/>	Pneumatic casters (1 ¼")		6"	\$165
CA14 to CA16	<input type="checkbox"/>	Newton UltraCaster Composite (1 ½ ")		4", 5", 6"	\$95
CA17 to CA19	<input type="checkbox"/>	Newton UltraCaster Aluminum (1 ½ ")		4", 5", 6"	\$215
CASTER OPTIONS					
CA13	<input type="checkbox"/>	Carbon fiber Frog Legs suspension forks (Not available with caster pin locks)		E1015	\$490

REAR Seat-to-floor Height

WHEEL SIZES		Height available	Specify desired height: _____ (inches)
<input type="checkbox"/>	22" (501) wheel	13 1/2" to 18 1/4"	
<input type="checkbox"/>	24" (540) wheel	14 1/2" to 18 1/4"	
<input type="checkbox"/>	25" (559) wheel	15" to 19 3/4"	
<input type="checkbox"/>	26" (590) wheel	15 1/2" to 20 1/4"	

Configuration used: 1" seat slope with a center of gravity at 2"

Note: Tire size, center of gravity setting and seat slope may result in a variation of +/- ½" of selected seat to floor height"

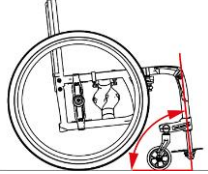
FRONT FRAME ANGLE					
FA70	<input type="checkbox"/>	70° Front frame angle			NC
FA75	<input type="checkbox"/>	75° Front frame angle			NC
FA80	<input type="checkbox"/>	80° Front frame angle			NC
FA85	<input type="checkbox"/>	85° Front frame angle			NC
FA90	<input type="checkbox"/>	90° Front frame angle			NC

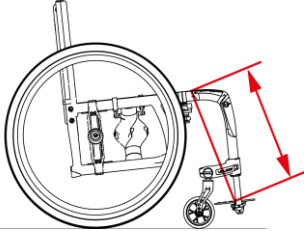
SEAT TO FOOTREST LENGTH					
Set Length to ¹ :	Length must be at least 1 ¼" shorter than front seat-to-floor height				
1 - +/- 1/2"					

Seat Width	Footrest width / Taper selection	
	Straight ¹	1" Taper
Outside Measurement	2 ½" Narrower than Seat Width	4 ¼" Narrower than Seat Width
14"	11.5"	9.5"
15"	12.5"	10.5"
16"	13.5"	11.5"
17"	14.5"	12.5"
18"	15.5"	13.5"
19"	16.5"	14.5"
20"	17.5"	15.5"
21"	18.5"	16.5"
22"	19.5"	17.5"

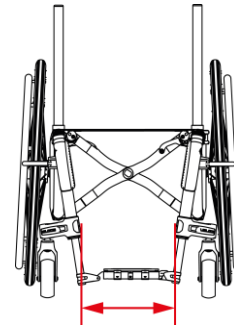

¹- Not compatible with auto-folding footplates

FOOTPLATES					
FP06	<input type="checkbox"/>	One piece adjustable angle flip-up - Aluminum		K0040	NC
FP07	<input type="checkbox"/>	One piece adjustable angle flip-up - Carbon fiber with rubber inserts			\$465
FP28	<input type="checkbox"/>	One piece auto-folding adjustable angle - Aluminum		K0040	\$295
FP29	<input type="checkbox"/>	One piece auto-folding adjustable angle - Carbon fiber with rubber inserts			\$375
FOOTPLATE ACCESSORIES					
FP08	<input type="checkbox"/>	Length adjustable heel loop (not available with one piece footplate)		E0951	\$41
FP09	<input type="checkbox"/>	Calf strap		K0038	\$36
FP30	<input type="checkbox"/>	Bodypoint Aeromesh Padded calf strap		K0038	\$118

Backrest

FIXED HEIGHT WITHOUT PUSH HANDLE OPTIONS						
BC03-9		Ultraight carbon fiber back cane	9"		*Temporarily unavailable	NC
BC03-12		Ultraight carbon fiber back cane	12"		*Temporarily unavailable	NC
BC03-15		Ultraight carbon fiber back cane	15"		*Temporarily unavailable	NC
BC03-18		Ultraight carbon fiber back cane	18"		*Temporarily unavailable	NC
BC03-21		Ultraight carbon fiber back cane	21"		*Temporarily unavailable	NC
BC04-13		8° bend carbon fiber back cane	13 ½"		*Temporarily unavailable	\$60
BC04-15		8° bend carbon fiber back cane	15"		*Temporarily unavailable	\$60
BC04-18		8° bend carbon fiber back cane	18"		*Temporarily unavailable	\$60
* Replacement options below: 1-Carbon fiber height adjustable; 2- Fixed height aluminum; 3- carbon fiber height and angle adjustable						
HEIGHT ADJUSTABLE WITH PUSH HANDLES OPTIONS (MUST select ONE push handle options)						
BC06-912	<input type="checkbox"/>	Straight Carbon fiber back cane	9" - 12"	increment of 1/2"	Set at ² :	NC
BC06-1215	<input type="checkbox"/>	Straight Carbon fiber back cane	12" - 15"	increment of 1/2"	Set at ² :	NC
BC06-1518	<input type="checkbox"/>	Straight Carbon fiber back cane	15" - 18"	increment of 1/2"	Set at ² :	NC
BC06-1821	<input type="checkbox"/>	Straight Carbon fiber back cane	18" - 21"	increment of 1/2"	Set at ² :	NC
BC08-1315	<input type="checkbox"/>	8° Bend Carbon fiber back cane	13.5" - 15"	increment of 1/2"	Set at ² :	\$60
BC08-1518	<input type="checkbox"/>	8° Bend Carbon fiber back cane	15" - 18"	increment of 1/2"	Set at ² :	\$60
BC08-1821	<input type="checkbox"/>	8° Bend Carbon fiber back cane	18" - 21"	increment of 1/2"	Set at ² :	\$60
FIXED HEIGHT WITHOUT PUSH HANDLE OPTIONS						
BC30	<input type="checkbox"/>	Straight aluminum back cane	9"			NC
BC36	<input type="checkbox"/>	Straight aluminum back cane	12"			NC
BC42	<input type="checkbox"/>	Straight aluminum back cane	15"			NC
BC63	<input type="checkbox"/>	8° bend aluminum back cane	13 ½"			\$60
BC64	<input type="checkbox"/>	8° bend aluminum back cane	15"			\$60
ANGLE AND HEIGHT ADJUSTABLE BACK CANE WITH PUSH HANDLE OPTIONS (MUST select ONE push handle options)						
BC09-1215	<input type="checkbox"/>	Straight Carbon fiber back cane	12" - 15"	increment of 1/2"	Set at ² :	\$215
BC09-1518	<input type="checkbox"/>	Straight Carbon fiber back cane	15" - 18"	increment of 1/2"	Set at ² :	\$215
BC09-1821	<input type="checkbox"/>	Straight Carbon fiber back cane	18" - 21"	increment of 1/2"	Set at ² :	\$215
BC10-1315	<input type="checkbox"/>	8° bend Carbon fiber back cane	13.5" - 15"	increment of 1/2"	Set at ² :	\$270
BC10-1518	<input type="checkbox"/>	8° bend Carbon fiber back cane	15" - 18"	increment of 1/2"	Set at ² :	\$270
BC10-1821	<input type="checkbox"/>	8° bend Carbon fiber back cane	18" - 21"	increment of 1/2"	Set at ² :	\$270
		Select back cane angle:	85° ¹ <input type="checkbox"/>	90° <input type="checkbox"/>	95° STD <input type="checkbox"/>	100° <input type="checkbox"/>
			105° <input type="checkbox"/>	110° <input type="checkbox"/>		
PUSH HANDLES OPTIONS (ONE option at a time)						
PH01	<input type="checkbox"/>	Push handles				NC
PH05	<input type="checkbox"/>	Fold down push handles ^{3,5}				\$145
PH06-920	<input type="checkbox"/>	Clamp on height adjustable push handles 9 - 20" ^{3, 4, 5}				\$325
PH06-923	<input type="checkbox"/>	Clamp on height adjustable push handles 9 - 23" ^{3, 4, 5}				\$325
PH02	<input type="checkbox"/>	Omit push handles				NC
<small>1- Not available with 8° bend back cane; 2- If not indicated, default height setting is at the lowest position; measured from seat sling to top of back upholstery; 3- 265 lb weight limit 4- Not compatible with swing away armrests, 8° bend back canes; 5- Not compatible with headrest and attendant lock</small>						
BACK UPHOLSTERY						
BH07	<input type="checkbox"/>	Slip-on Active-Mesh back upholstery				STD
BH08	<input type="checkbox"/>	Adjustable tension Active-Mesh back upholstery			E2611/E2612	\$305
BH99	<input type="checkbox"/>	Omit Back upholstery				NC
	<input type="checkbox"/>	NXT back Support			See pricelist	
SEAT CUSHION						
SC01	<input type="checkbox"/>	2" Cushion				\$170
SC02	<input type="checkbox"/>	3" Cushion			E2601/E2602	\$190
SC99	<input type="checkbox"/>	Omit seat cushion				STD
	<input type="checkbox"/>	NXT cushion series			See pricelist	

Rear wheels													
ONE ARM DRIVE ¹ <i>Only available with Newton One rear wheels, permanent axles, 0° camber</i>													
HR22	<input type="checkbox"/>	One arm drive - aluminum inner handrim ²	Left <input type="checkbox"/>	Right <input type="checkbox"/>		\$1,495							
HR60	<input type="checkbox"/>	One arm drive - plastic coated inner handrim ²	Left <input type="checkbox"/>	Right <input type="checkbox"/>	E0958	\$1,600							
HR98	<input type="checkbox"/>	Omit handrim on opposite side of the One Arm Drive (OAD)				NC							
REAR WHEELS					Available								
RW01	<input type="checkbox"/>	Mag ³			22" 24"	\$57							
RW02	<input type="checkbox"/>	Newton One - spoke wheel ⁴			22" 24"	NC							
RW03	<input type="checkbox"/>	Newton Gravity - ultralight wheel			22", 24", 25", 26"	\$360							
RW04	<input type="checkbox"/>	Spinergy Spox	Blk STD <input type="checkbox"/>	Wht ⁵ <input type="checkbox"/>	Blue ⁵ <input type="checkbox"/>	Red ⁵ <input type="checkbox"/>	Yel ⁵ <input type="checkbox"/>	22", 24", 25", 26"	\$915				
RW05	<input type="checkbox"/>	Spinergy LX	Blk STD <input type="checkbox"/>	Pur ⁵ <input type="checkbox"/>	Wht ⁵ <input type="checkbox"/>	Blue ⁵ <input type="checkbox"/>	Red ⁵ <input type="checkbox"/>	Yel ⁵ <input type="checkbox"/>	Pink ⁵ <input type="checkbox"/>	Grn ⁵ <input type="checkbox"/>	Org ⁵ <input type="checkbox"/>	22", 24", 25", 26"	\$1,145
RW07	<input type="checkbox"/>	Spinergy CLX ⁶	Blk STD <input type="checkbox"/>	Pur ⁵ <input type="checkbox"/>	Wht ⁵ <input type="checkbox"/>	Blue ⁵ <input type="checkbox"/>	Red ⁵ <input type="checkbox"/>	Yel ⁵ <input type="checkbox"/>	Pink ⁵ <input type="checkbox"/>	Grn ⁵ <input type="checkbox"/>	Org ⁵ <input type="checkbox"/>	24", 25"	\$1,625
TIRES					Available								
AIRLESS													
TI01	<input type="checkbox"/>	Soft Urethane 1 3/8" - Low Tread, black ⁹			22" 24"	E2218	NC						
TI02	<input type="checkbox"/>	Soft Urethane 1 3/8" - Medium Tread, black ^{7,9}			22", 24", 25", 26"	E2218	\$97						
TI04	<input type="checkbox"/>	Soft Urethane 1" - No tread, black - Shox			22", 24", 25", 26"	E2218	\$118						
TI08	<input type="checkbox"/>	Pneumatic Airless insert 1 3/8" - Medium Tread ⁸			22", 24", 26"	E2211/E2213	\$82						
PNEUMATIC													
TI05	<input type="checkbox"/>	Pneumatic 1 3/8" - Medium Tread ⁹			22", 24", 25", 26"	E2211/E2212	NC						
TI06	<input type="checkbox"/>	Pneumatic HP 1" - Low Tread, Puncture resistant, black - SpeedLite			22", 24", 25", 26"	E2211/E2212	\$105						
TI07	<input type="checkbox"/>	Pneumatic HP 1" - Medium Tread, Puncture resistant, black - TrailBlazer			24", 25", 26"	E2211/E2212	\$150						
TI03	<input type="checkbox"/>	Pneumatic 2" - Large Tread, black ¹⁰			22", 24", 25"	E2211/E2212	\$115						

1- Offered with handrims on each side of the wheelchair; select the outer handrim in the handrims section; **Only available with 24" wheel size; Not available with 21" and 22" wide**; 2- Only standard handrim position available;
3- Not compatible with HP tires; Only available with aluminum or plastic coated handrim, standard position; 4- Not compatible with Shox tires; 5- color spokes require an additional 10 days lead-time;
6- Only available with 1" tires; 7- 22" is only available with Mags and Newton One rear wheels; 8- Not available with Spinergy CLX, Spinergy LX 25", 26" and Spox 25", 26" rear wheels;
9- Not available with flip-back armrest when the 6° camber is selected; 10- Not available with armrests when the 3° or 6° camber are selected;

Handrims						
HANDRIM					Available	
HR01	<input type="checkbox"/>	Aluminum anodized			22", 24", 25", 26"	STD
HR61	<input type="checkbox"/>	Aluminum black hard anodized ²			22", 24", 25"	\$75
HR02	<input type="checkbox"/>	Plastic coated ¹			22", 24", 25", 26"	\$110
HR03	<input type="checkbox"/>	High friction coated ^{1,2,3}			22", 24", 25", 26"	\$375
HR07-HR18 and HR65- HR71	<input type="checkbox"/>	Newton Air Grip ²	<i>See page 6 for the color selection and price</i>		22", 24", 25", 26"	
HR28	<input type="checkbox"/>	Surge ^{1,2,3} (1 1/2" Oval handrim w/ Gripton high friction strip)			22", 24", 25", 26"	\$450
HR05	<input type="checkbox"/>	Surge LT ^{1,2,3} (1 1/8" Oval handrim w/ Gripton high friction strip)			22", 24", 25", 26"	\$495
HR04	<input type="checkbox"/>	Natural Fit ^{1,2,3}			22", 24", 25", 26"	\$395
HR62	<input type="checkbox"/>	Simi H ^{1,2,3} (1 3/8" Oval handrim with high friction strip)			22", 24", 25", 26"	\$395
HR63	<input type="checkbox"/>	Nova H ^{1,2,3} (1 1/4" Oval handrim with high friction strip)			22", 24", 25", 26"	\$445
HR64	<input type="checkbox"/>	Optimum H ^{1,2,3} (1 1/8" heart-shaped handrim)			22", 24", 25", 26"	\$345
HR99	<input type="checkbox"/>	Omit handrim				NC

1- Only standard and narrow handrim position. By default, the tab won't be cut with the narrow position; 2- Not available with Mag wheels; 3 - Not available with one arm drive;

Handrims option						
ASSEMBLY POSITION					Available	
HR29	<input type="checkbox"/>	Standard Handrim position	Full tab			STD
HR030	<input type="checkbox"/>	Narrow Handrim position no cut	Full tab			NC
HR30	<input type="checkbox"/>	Narrow Handrim position with cut ³	Short tab 2 positions			\$30
HR31	<input type="checkbox"/>	Super Narrow Handrim ³	Short tab 2 positions STD <input type="checkbox"/>		Short tab 1 position <input type="checkbox"/>	
THUMB PIECE SELECTION FOR NATURAL FIT, SURGE, SURGE LT HANDRIMS					Available	
HR23	<input type="checkbox"/>	Standard grip				\$95
HR27	<input type="checkbox"/>	Super grip				\$150
HR099	<input type="checkbox"/>	Omit thumb piece				NC

3- Only available with Aluminum and Air Grip handrims;

AXLE ¹					
AX01	<input type="checkbox"/>	Quick release axle			STD
AX03	<input type="checkbox"/>	Quad release axle		K0108	\$130

¹- Not required with one arm drive

REAR WHEEL CAMBER ANGLE					
CM00	<input type="checkbox"/>	0° camber			STD
CM03	<input type="checkbox"/>	3° camber			NC
CM06	<input type="checkbox"/>	6° camber			\$165

CENTER OF GRAVITY

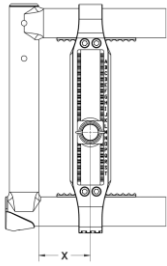

Choose position of rear wheel axle plate:

Measure distance X from front of back post to center of axle receiver.

Most stable													
X =	1"	1/4"	1/2"	3/4"	2"	1/4"	1/2"	3/4"	3"	1/4"	1/2"	3/4"	4"
	<input type="checkbox"/>	<input type="checkbox"/>	<input type="checkbox"/>	<input type="checkbox"/>	<input type="checkbox"/>	<input type="checkbox"/>	<input type="checkbox"/>	<input type="checkbox"/>	<input type="checkbox"/>	<input type="checkbox"/>	<input type="checkbox"/>	<input type="checkbox"/>	<input type="checkbox"/>

If not indicated, default setting is at 1.5"

Possible conflict between a seat depth under 16" and a center of gravity over 2.5".

Possible conflict between a 26" rear wheel and a center of gravity over 2.5".

Motion Composites will select the closest possible center of gravity (COG) if an issue arises with the COG

WHEEL LOCK					
WL08	<input type="checkbox"/>	Newton Wheel lock - push to lock			STD
WL16	<input type="checkbox"/>	Aluminum push to lock with extensions		E0961	\$77
WL02	<input type="checkbox"/>	Pull to lock			NC
WL04	<input type="checkbox"/>	Newton grade aid push to lock (<i>works best with pneumatic or high pressure tire</i>)		E0974	\$155
WL13	<input type="checkbox"/>	6" removable extension handle ¹		E0961	\$77
WL14					
WL05	<input type="checkbox"/>	Scissors Lock			\$155
WL15	<input type="checkbox"/>	Unilateral wheel lock - pull to lock ²	Left <input type="checkbox"/>	Right <input type="checkbox"/>	\$330
WL99	<input type="checkbox"/>	Omit wheel locks			NC

¹ - Only available with Newton push to lock (WL08), pull to lock (WL02) and Newton Grade aid (WL04)

² - For more information about incompatibilities and restriction, refer to the table at page 7 and the "How-to documents" page of our website:

https://www.motioncomposites.com/en_ca/support-and-education/how-to-documents

Armrests

HEIGHT ADJUSTABLE FLIP BACK ARMREST (Convertible to "T" armrest) ¹					
AR01-812	<input type="checkbox"/>	10" Desk length armpad 8" - 12"	Locked <input type="checkbox"/>	Unlocked STD <input type="checkbox"/>	\$355
AR01-1014	<input type="checkbox"/>	10" Desk length armpad 10" - 14"	Locked <input type="checkbox"/>	Unlocked STD <input type="checkbox"/>	\$355
AR02-812	<input type="checkbox"/>	14" Full length armpad 8" - 12"	Locked <input type="checkbox"/>	Unlocked STD <input type="checkbox"/>	\$355
AR02-1014	<input type="checkbox"/>	14" Full length armpad 10" - 14"	Locked <input type="checkbox"/>	Unlocked STD <input type="checkbox"/>	\$355

HEIGHT ADJUSTABLE "T" ARMREST ¹					
AR13-610	<input type="checkbox"/>	10" Desk length armpad ⁴ 6" - 10"		E0973	\$330
AR03-812	<input type="checkbox"/>	10" Desk length armpad 8" - 12"		E0973	\$330
AR03-1014	<input type="checkbox"/>	10" Desk length armpad 10" - 14"		E0973	\$330
AR14-610	<input type="checkbox"/>	14" Full length armpad ⁴ 6" - 10"		E0973	\$330
AR04-812	<input type="checkbox"/>	14" Full length armpad 8" - 12"		E0973	\$330
AR04-1014	<input type="checkbox"/>	14" Full length armpad 10" - 14"		E0973	\$330

HEIGHT ADJUSTABLE SWING AWAY ARMREST ²					
AR05	<input type="checkbox"/>	Tubular armrest without plastic side guards - Short pad	8" - 11"	E0973	\$230
AR19	<input type="checkbox"/>	Tubular armrest with plastic side guards - Short pad	8" - 11"	E0973	\$395
AR23	<input type="checkbox"/>	Tubular armrest without plastic side guards - Long pad	8" - 11"	E0973	\$230
AR24	<input type="checkbox"/>	Tubular armrest with plastic side guards - Long pad	8" - 11"	E0973	\$395
AR06	<input type="checkbox"/>	10" Desk length flat armpad without plastic side guards	8" - 11"	E0973	\$230
AR20	<input type="checkbox"/>	10" Desk length flat armpad with plastic side guards	8" - 11"	E0973	\$395
AR17	<input type="checkbox"/>	14" Full length flat armpad without plastic side guards	8" - 11"	E0973	\$230
AR21	<input type="checkbox"/>	14" Full length flat armpad with plastic side guards	8" - 11"	E0973	\$395

ARMREST OPTIONS					
AR12	<input type="checkbox"/>	14" Full Length armpad - Gel Ovation ³			\$165
AR99	<input type="checkbox"/>	Omit armrest			NC

¹ - May have a 1/2" adjustment restriction on both limits of the range; ² - Could interfere with some rigid backrests; Not available with fixed carbon fiber side guards

³ - Only available with full length armrest; Not available with swing away and desk length armrests; ⁴ - May have some restriction with seat-to-floor height and rear wheel

SIDE GUARDS (not available with Flip Back and "T" Armrest)

SG01	<input type="checkbox"/>	Plastic side guards (removable)	Straight bracket - STD	Offset bracket ¹	PRODUCT IMPROVED	K0108	\$200
SG02	<input type="checkbox"/>	Carbon fiber side guards (fixed)					\$270
SG03	<input type="checkbox"/>	Carbon fiber side guards (removable)	Straight bracket - STD	Offset bracket ¹	PRODUCT IMPROVED	K0108	\$305
SG06	<input type="checkbox"/>	Plastic fender side guards (removable)	Straight bracket - STD	Offset bracket ¹		K0108	\$290
SG04	<input type="checkbox"/>	Carbon fiber fender side guards (removable)	Straight bracket - STD	Offset bracket ¹	PRODUCT IMPROVED		\$550
SG99	<input type="checkbox"/>	Omit side guard					NC

SIDE GUARDS OPTION					
SG07	<input type="checkbox"/>	Side guards clip (pair) ²			NC

¹ - only compatible with 0° camber; increase width by 1/2" per side for a total of 1"; ² - Not available with fixed carbon fiber side guard

POSITIONING BELT					
SB01-S	<input type="checkbox"/>	Velcro adjustable - Small 35" ¹		E0978	\$46
SB01-L	<input type="checkbox"/>	Velcro adjustable - Long 60"		E0978	\$46
SB02-S	<input type="checkbox"/>	Auto buckle - Small 35" ¹		E0978	\$87
SB02-M	<input type="checkbox"/>	Auto buckle - Medium 48"	<i>New</i>	E0978	\$87
SB02-L	<input type="checkbox"/>	Auto buckle - Long 60"		E0978	\$87
SB04-M	<input type="checkbox"/>	BodyPoint Hip Belt - 2 point not padded - Medium 56"		E0978	\$85
SB04-L	<input type="checkbox"/>	BodyPoint Hip Belt - 2 point not padded - Long 61"		E0978	\$85
SB05-S	<input type="checkbox"/>	BodyPoint Hip Belt - 2 point padded - Small 51"		E0978	\$180
SB05-M	<input type="checkbox"/>	BodyPoint Hip Belt - 2 point padded - Medium 56"		E0978	\$180
SB05-L	<input type="checkbox"/>	BodyPoint Hip Belt - 2 point padded - Long 61"		E0978	\$180
SB06-S	<input type="checkbox"/>	BodyPoint Hip Belt - 4 point padded - Small 51"		E0978	\$195
SB06-M	<input type="checkbox"/>	BodyPoint Hip Belt - 4 point padded - Medium 56"		E0978	\$195
SB06-L	<input type="checkbox"/>	BodyPoint Hip Belt - 4 point padded - Long 61"		E0978	\$195
SB03	<input type="checkbox"/>	Hardware attachment for 2 extra points (1 pair)			\$17
SB08-M	<input type="checkbox"/>	BodyPoint EVOFLEX® Positioning Belt Rehab latch and Band Clamps - Medium 18"		K0108	\$305
SB08-L	<input type="checkbox"/>	BodyPoint EVOFLEX® Positioning Belt Rehab latch and Band Clamps - Long 24"		K0108	\$305
SB99	<input type="checkbox"/>	Omit positioning belt			STD

1- not recommended for seat width of 18" and more





























































HEADREST ¹					
AC01-S	<input type="checkbox"/>	Profiled Headrest - Small (3.5"X6")		E0955	\$185
AC01-M	<input type="checkbox"/>	Profiled Headrest - Medium (4.5"X7")		E0955	\$185
AC01-L	<input type="checkbox"/>	Profiled Headrest - Large (5.5"X8")		E0955	\$185
AC28	<input type="checkbox"/>	Headrest mounting hardware with stabilizer bar 1		E1028	\$300

1- Only available with push handles

ACCESSORIES					
AC03	<input type="checkbox"/>	Anti-tippers		E0971	\$145
AC29	<input type="checkbox"/>	Swing-away anti-tipper ¹	Left <input type="checkbox"/> Right <input type="checkbox"/>		\$190
AC27	<input type="checkbox"/>	Tip assist ²			\$67
AC06	<input type="checkbox"/>	Cane and crutch holder	Left <input type="checkbox"/> Right <input type="checkbox"/>	E2207	\$200
AC08	<input type="checkbox"/>	Spoke guards ³	Available: 22", 24", 26"	K0065	\$118
AC10	<input type="checkbox"/>	Seat pouch			\$82
AC26	<input type="checkbox"/>	BodyPoint Mobility Bag			\$135
AC23	<input type="checkbox"/>	Newton Backpack			\$130
AC30	<input type="checkbox"/>	Newton multi-purpose pouch			\$61
AC12	<input type="checkbox"/>	Velcro Closing Strap			\$57
AC13	<input type="checkbox"/>	Tool kit			\$51
AC16	<input type="checkbox"/>	Motion Composites Polo Shirt	W/S <input type="checkbox"/> W/M <input type="checkbox"/> W/L <input type="checkbox"/> M/S <input type="checkbox"/> M/M <input type="checkbox"/> M/L <input type="checkbox"/> M/XL <input type="checkbox"/> M/XXL <input type="checkbox"/> M/XXXL <input type="checkbox"/>		\$36
AC15	<input type="checkbox"/>	Military Patches	Army <input type="checkbox"/> Navy <input type="checkbox"/> Air Force <input type="checkbox"/> Marines <input type="checkbox"/> Coast Guard <input type="checkbox"/> Combat Wounded Purple Heart <input type="checkbox"/> Space Force <input type="checkbox"/> American Flag <input type="checkbox"/>		\$96

1- Must select the pair (left and right) with HD option; Only available with rear seat to floor height between 13 1/2" and 19 3/4"; 2- Cannot be combined with Anti Tippers

3- Not available with Mag wheels and Spinerig

Colors																						
Options ¹	Black	High Gloss Carbon Fiber	Sunkissed Orange	Burgundy	Sapphire Blue	Monster Green	Charcoal	Fuchsia	Steel Blue	Ferrari Red	Acid Green	Electric Purple	Caribbean Blue	White	Pink Pearl	Plum Purple	Sky Blue	Black Cherry	Khaki Green (matte)	Desert Sand (matte)		
AirGrip	<input type="checkbox"/>																					\$265
Frame	<input type="checkbox"/>																					NC
Highlight ²	<input type="checkbox"/>																					NC
FC99	<input type="checkbox"/>	Custom Color	Specify PPG Paintit color:																	<i>additional 10 days lead-time</i>	\$390	

1- Color representation may vary from one monitor to another. Therefore, the actual paint color on your wheelchair might differ slightly from what you see on your screen.; Finish between Airgrip and frame might be different;

2- To see different highlight, visit our website: https://www.motioncomposites.com/en_us/products/folding-wheelchairs/veloce

Frame length chart

Frame length	Seat Depth						
	14"	15"	16"	17"	18"	19"	20"
STD	N/A	15"	16"	17"	18"	19"	20"
1	15"	16"	17"	18"	19"	20"	N/A
2	16"	17"	18"	19"	20"	N/A	N/A
-1	N/A	N/A	15"	16"	17"	18"	19"
-2	N/A	N/A	N/A	15"	16"	17"	18"

Unilateral wheel lock restrictions

Seat depth: shall be 16 in and greater		
Rear wheel: shall be 24 in and less		
"T" or flip-back armrest only compatible with 0° Camber		
One arm drive: Not compatible with "T" or flip-back armrest		
"T" or flip-back armrest may require to move the rear wheels outwards		
Not compatible with wheel lock lever extension		
Rear wheel diameter	Seat depth (in)	COG Compatibility Range (in)
20 in	16+	1.75 to 4
22 in	16+	2.5 to 4
24 in	16+	1 to 4

Notes :

FOLDING ON CHAIR - USA ORDER FORM

BioFit™ CUSHION		WIDTH										
		12"	13"	14"	15"	16"	17"	18"	19"	20"	21"	22"
DEPTH	12"	\$445	\$445	\$445								
	14"	\$445	\$445	\$445								
	15"		\$445	\$445	\$445	\$445						
	16"		\$445	\$445	\$445	\$445	\$445	\$445	\$480	\$480	\$480	\$480
	17"				\$445	\$445	\$445	\$445	\$480	\$480		
	18"				\$445	\$445	\$445	\$445	\$480	\$480	\$480	\$480
	19"				\$445	\$445	\$445	\$445	\$480	\$480		
	20"				\$445	\$445	\$445	\$480	\$480	\$480	\$480	\$480
Option: Change cover for incontinent/infection control outer cover												N/C

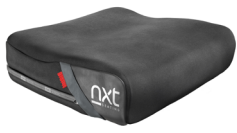

NXCABF _____
(W" x D")

HCPCS CODE: E2607-E2608

SEATING AND CUSHION ACCESSORIES

	MODEL NO.	Description	Fits Back Width	\$	QTY
	RSSI 1600	Solid Seat Insert	Fits cushions 16" & 17" wide (40.6 & 43.2 cm) and 14"-18" deep (35.6-45.7 cm)	80	
	RSSI 1800	Solid Seat Insert	Fits cushions 18" & 19" wide (45.7 & 48.3 cm) and 14"-18" deep (35.6-45.7 cm)	80	
	RSSI 2000	Solid Seat Insert	Fits cushions 20"-22" wide (50.8-55.9 cm) and 18"-20" deep (45.7-50.8 cm)	80	

Optima™ THORACIC BACK SUPPORT

CARBON FIBER SHELL (WEIGHT SAVINGS - 1lb)

HCPCS CODE: E2620-E2621

Optima™ DEEP THORACIC BACK SUPPORT

CARBON FIBER SHELL (WEIGHT SAVINGS - 1lb)

HCPCS CODE: E2620-E2621

THORACIC SHAPE

WIDTH	HEIGHT	MODEL # CARBON FIBER	\$ CARBON	MODEL # ALUMINUM	\$ ALUMINUM
14"	13"	NOCFACB1413	\$925	NOACB1413	\$695
14"	16"	NOCFACB1416	\$960	NOACB1416	\$695
15"	13"	NOCFACB1513	\$925	NOACB1513	\$695
15"	16"	NOCFACB1516	\$960	NOACB1516	\$695
16"	13"	NOCFACB1613	\$925	NOACB1613	\$695
16"	16"	NOCFACB1616	\$960	NOACB1616	\$695
16"	19"			NOACB1619	\$695
17"	13"	NOCFACB1713	\$925	NOACB1713	\$695
17"	16"	NOCFACB1716	\$960	NOACB1716	\$695
18"	13"	NOCFACB1813	\$925	NOACB1813	\$695
18"	16"	NOCFACB1816	\$960	NOACB1816	\$695
18"	19"			NOACB1819	\$695
19"	16"			NOACB1916	\$695
19"	19"			NOACB1919	\$695
20"	13"	NOCFACB2013	\$925	NOACB2013	\$695
20"	16"	NOCFACB2016	\$960	NOACB2016	\$695
20"	19"			NOACB2019	\$695
21"	16"			NOACB2116	\$745
21"	19"			NOACB2119	\$745
22"	13"			NOACB2213	\$745
22"	16"			NOACB2216	\$745
22"	19"			NOACB2219	\$745

WIDTH	HEIGHT	MODEL # CARBON FIBER	\$ CARBON	MODEL # ALUMINUM	\$ ALUMINUM
14"	13"	NOCFPCB1413	\$1015	NOPCB1413	\$695
14"	16"	NOCFPCB1416	\$1055	NOPCB1416	\$695
15"	13"	NOCFPCB1513	\$1015	NOPCB1513	\$695
15"	16"	NOCFPCB1516	\$1055	NOPCB1516	\$695
16"	13"	NOCFPCB1613	\$1015	NOPCB1613	\$695
16"	16"	NOCFPCB1616	\$1055	NOPCB1616	\$695
16"	19"			NOPCB1619	\$695
17"	13"	NOCFPCB1713	\$1015	NOPCB1713	\$695
17"	16"	NOCFPCB1716	\$1055	NOPCB1716	\$695
18"	13"	NOCFPCB1813	\$1015	NOPCB1813	\$695
18"	16"	NOCFPCB1816	\$1055	NOPCB1816	\$695
18"	19"			NOPCB1819	\$695
19"	16"			NOPCB1916	\$695
19"	19"			NOPCB1919	\$695
20"	13"	NOCFPCB2013	\$1015	NOPCB2013	\$695
20"	16"	NOCFPCB2016	\$1055	NOPCB2016	\$695
20"	19"			NOPCB2019	\$695
21"	16"			NOPCB2116	\$745
21"	19"			NOPCB2119	\$745
22"	13"			NOPCB2213	\$745
22"	16"			NOPCB2216	\$745
22"	19"			NOPCB2219	\$745

ITEM	WIDTH X DEPTH	\$	QTY
Replacement Cover & Foam	NOACC _____	130	

ITEM	WIDTH X DEPTH	\$	QTY
Replacement Cover & Foam	NOPCC _____	130	

PLEASE NOTE: Each back will fit widths up to 2" wider.

ALL PRICES QUOTED IN USD. PRICES ARE SUBJECT TO CHANGE WITHOUT NOTICE.

For additional NXT models, sizes and hardware not shown, please refer to the complete NXT Seating Order Form at www.motioncomposites.com

FOLDING ON CHAIR - USA ORDER FORM

Xtend™ LOW HEIGHT ADJUSTABLE THORACIC BACK SUPPORT

Xtend™ DEEP HEIGHT ADJUSTABLE THORACIC BACK SUPPORT

THORACIC SHAPE		xtend™	WIDTH	HEIGHT	✓	\$
		**NHAACB (L)1213/17	12"	13"-17"		\$695
		NHAACB (L)1413/17	14"	13"-17"		\$695
		NHAACB (L)1613/17	16"	13"-17"		\$695
		NHAACB (L)1813/17	18"	13"-17"		\$745
		NHAACB (L)2013/17	20"	13"-17"		\$745
		NHAACB (L)2213/17	22"	13"-17"		\$745
HCPCS CODE: E2620-E2621						
ITEM	WIDTH X DEPTH	\$	QTY			
Replacement Cover & Foam	N3LHAACC _ _ _ _	130				

	xtend™ DEEP	WIDTH	HEIGHT	✓	\$
	NHAPCB1616/20	16"	16"-20"		\$695
	NHAPCB1816/20	18"	16"-20"		\$695
	NHAPCB2016/20	20"	16"-20"		\$695
	NHAPCB2216/20	22"	16"-20"		\$745
	HCPCS CODE: E2620-E2621				
ITEM	WIDTH X DEPTH	\$	QTY		
Replacement Cover & Foam	N3HAPCC _ _ _ _	130			

PLEASE NOTE: Each back will fit widths up to 2" wider.

Classic™ PELVIC BACK SUPPORT

Classic™ DEEP PELVIC BACK SUPPORT

PELVIC SHAPE		Classic™	WIDTH	HEIGHT	✓	\$
		NACB1616	16"-18"	16"		\$695
		NACB1618	16"-18"	18"		\$695
		NACB1816	18"-20"	16"		\$695
		NACB1818	18"-20"	18"		\$695
		NACB1820	18"-20"	20"		\$695
		NACB2020	20"-22"	20"		\$695
		NACB2216	22"-24"	16"		\$745
		NACB2218	22"-24"	18"		\$745
		NACB2220	22"-24"	20"		\$745
HCPCS CODE: E2620-E2621						
ITEM	WIDTH X DEPTH	\$	QTY			
Replacement Cover & Foam	NACC _ _ _ _	130				

	Classic DEEP™	WIDTH	HEIGHT	✓	\$
	NPCB1616	16"-18"	16"		\$695
	NPCB1618	16"-18"	18"		\$695
	NPCB1818	18"-20"	18"		\$695
	NPCB1820	18"-20"	20"		\$695
	NPCB2020	20"-22"	20"		\$695
	NPCB2216	22"-24"	16"		\$745
	NPCB2218	22"-24"	18"		\$745
	NPCB2220	22"-24"	20"		\$745
	HCPCS CODE: E2620-E2621				
ITEM	WIDTH X DEPTH	\$	QTY		
Replacement Cover & Foam	NPCC _ _ _ _	130			

PLEASE NOTE: Each back will fit widths up to 2" wider.

BACK SUPPORT ACCESSORIES

	MODEL #	DESCRIPTION	FITS BACK WIDTH	\$	QTY
	Custom - Cover	Optional Infection Control Wipe Down Back Support Cover	Specify back model # when ordering	205	
	NIB-1938	Extra Small Privacy Flap for 11" - 13" wide back supports	11" - 13" (27.9 - 33.0)	70	
	NIB-1078	Small Privacy Flap for 14"-16" wide back supports	14" - 16" (35.6-40.6 cm)	70	
	NIB-1079	Medium Flap for 17"-19" wide back supports	17" - 19" (43.2-48.3 cm)	70	
	NIB-1080	Large Privacy Flap for 20"-22" wide back supports	20" - 22" (50.8-55.9 cm)	70	
	NIB-1081	Extra Large Privacy Flap for 23" - 26" wide back supports	23" - 26" (58.4 - 66.0 cm)	70	

MultiFit™ HEAD SUPPORT - MULTI-ADJUSTABLE PADS

	HCPCS CODE: E0955
MODEL # NIB-0784	✓ \$
10" x 5" Large Rectangular	\$205

	HCPCS CODE: E0955
MODEL # NIB-0818	✓ \$
14" x 5" Extra-Large Rectangular	\$205

MultiFit™ HEAD SUPPORT - FIXTURES

	HCPCS CODE: E0955
MODEL # NIB-0747	✓ \$
Multi-Axis Hardware	\$150

	HCPCS CODE: E0955
MODEL # NIB-0823	✓ \$
Head Support Receiver Bracket	\$60

ALL PRICES QUOTED IN USD. PRICES ARE SUBJECT TO CHANGE WITHOUT NOTICE.

For additional NXT models, sizes and hardware not shown, please refer to the complete NXT Seating Order Form at www.motioncomposites.com

EXTRA COVERS

Extra Outer smartx^{3D} Cover



Extra Outer Incontinent Cover



ITEM	WIDTH X DEPTH	\$	QTY
Extra Outer smartx ^{3D} Cover - For a cover up to 18" x 18"	__ __ x __ __	130	
Extra Outer smartx ^{3D} Cover - For a cover 18" x 20" and above	__ __ X __ __	150	
Extra Outer Incontinent Cover - For a cover up to 18" x 18"	__ __ X __ __	130	
Extra Outer Incontinent Cover - For a cover 18" x 20" and above	__ __ X __ __	150	